

# AERO

## TGB SERIES 4" & 10" Backsplash, Galvanized Steel Undershef

# WORK TABLE

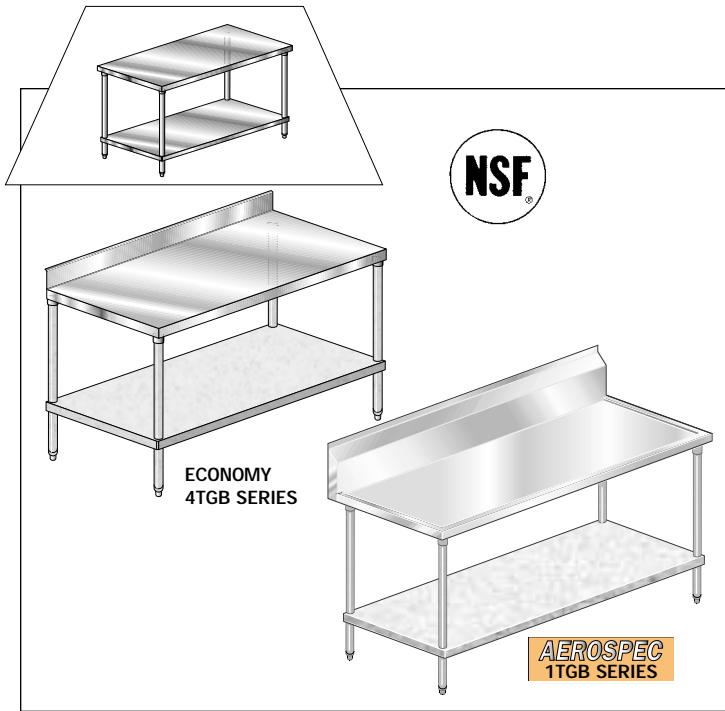

Item# \_\_\_\_\_ Project \_\_\_\_\_

Quantity	ECONOMY 16GA 430 Model #	DELUX 16GA 304 Model #	PREMIUM 14GA 304 Model #	AEROSPEC 14GA 304 Model #
----------	--------------------------------	------------------------------	--------------------------------	---------------------------------

### 24" WIDE

_____	4TGB-2424	3TGB-2424	2TGB-2424	1TGB-2424
_____	4TGB-2430	3TGB-2430	2TGB-2430	1TGB-2430
_____	4TGB-2436	3TGB-2436	2TGB-2436	1TGB-2436
_____	4TGB-2448	3TGB-2448	2TGB-2448	1TGB-2448
_____	4TGB-2460	3TGB-2460	2TGB-2460	1TGB-2460
_____	4TGB-2472	3TGB-2472	2TGB-2472	1TGB-2472
_____	4TGB-2484	3TGB-2484	2TGB-2484	1TGB-2484
_____	4TGB-2496	3TGB-2496	2TGB-2496	1TGB-2496
_____	4TGB-24108	3TGB-24108	2TGB-24108	1TGB-24108
_____	4TGB-24120	3TGB-24120	2TGB-24120	1TGB-24120
_____	4TGB-24132	3TGB-24132	2TGB-24132	1TGB-24132
_____	4TGB-24144	3TGB-24144	2TGB-24144	1TGB-24144

### 30" WIDE

_____	4TGB-3024	3TGB-3024	2TGB-3024	1TGB-3024
_____	4TGB-3030	3TGB-3030	2TGB-3030	1TGB-3030
_____	4TGB-3036	3TGB-3036	2TGB-3036	1TGB-3036
_____	4TGB-3048	3TGB-3048	2TGB-3048	1TGB-3048
_____	4TGB-3060	3TGB-3060	2TGB-3060	1TGB-3060
_____	4TGB-3072	3TGB-3072	2TGB-3072	1TGB-3072
_____	4TGB-3084	3TGB-3084	2TGB-3084	1TGB-3084
_____	4TGB-3096	3TGB-3096	2TGB-3096	1TGB-3096
_____	4TGB-30108	3TGB-30108	2TGB-30108	1TGB-30108
_____	4TGB-30120	3TGB-30120	2TGB-30120	1TGB-30120
_____	4TGB-30132	3TGB-30132	2TGB-30132	1TGB-30132
_____	4TGB-30144	3TGB-30144	2TGB-30144	1TGB-30144

### 36" WIDE

_____	4TGB-3636	3TGB-3636	2TGB-3636	1TGB-3636
_____	4TGB-3648	3TGB-3648	2TGB-3648	1TGB-3648
_____	4TGB-3660	3TGB-3660	2TGB-3660	1TGB-3660
_____	4TGB-3672	3TGB-3672	2TGB-3672	1TGB-3672
_____	4TGB-3684	3TGB-3684	2TGB-3684	1TGB-3684
_____	4TGB-3696	3TGB-3696	2TGB-3696	1TGB-3696
_____	4TGB-36108	3TGB-36108	2TGB-36108	1TGB-36108
_____	4TGB-36120	3TGB-36120	2TGB-36120	1TGB-36120
_____	4TGB-36132	3TGB-36132	2TGB-36132	1TGB-36132
_____	4TGB-36144	3TGB-36144	2TGB-36144	1TGB-36144

### MATERIAL

#### TOP

- 1 7/8" turn down on 3 sides.
- Rear has a 4" splash.
- Two heavy gauge steel box channels on 24" wide tables for rigidity.
- Three heavy gauge steel box channels on 30" tables for rigidity.
- Four heavy gauge steel box channels on 36" tables for rigidity.
- Sound deadened between table top and channels.

#### SHELF

- 18 gauge galvanized steel.

#### LEGS

- 1 1/2" O.D. 16 gauge galvanized steel tubing, complete with 1" adjustable, impact resistant, plastic feet.

### DESIGN FEATURES

- Undershef is the largest in the industry.
- Undershef is fully adjustable and flexible in design.
- All tables fully cartoned.
- Easily assembled.

### EXCLUSIVE AERO SAFETY EDGE

- Table and undershef hemmed to eliminate cuts from rough edges.

### CONSTRUCTION

- Top is polished to a #4 mill finish.
- Heliarc welded construction creates uniform, rock-solid unit.
- Gussets fully welded for extra rigidity.
- All tables shipped K.D.

### AEROSPEC

- 1TGB TABLES ARE **AEROSPEC DESIGNED**.  
*In addition to above specifications;*
- Three sides have a "V" countertop edge to inhibit spillage.
- Backsplash is 10" high including a 2" return on a 45 deg. angle.

SEE PAGES TS-5A & TS-5B  
TO CUSTOMIZE YOUR  
AERO TABLE

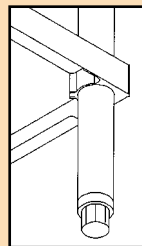

Adjustable  
Undershef  
with Exclusive  
**AEROLock**  
Extrusion

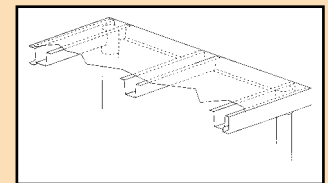

Strongest Construction  
in the Industry

SEE PAGES SP-6A & SP-6B  
TO DESIGN YOUR  
FLEXIBLE WORKCENTER

# BUILT TO LAST A LIFETIME



# DIMENSIONAL SPECIFICATIONS

TGB SERIES 4" & 10" Backsplash, Galvanized Steel Undershef

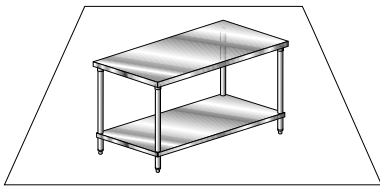

- Tables over 72" in length are shipped with six legs.
- Undershef O.D. Table Length -2", Table Width -2".
- All feet have a full 1" adjustability.

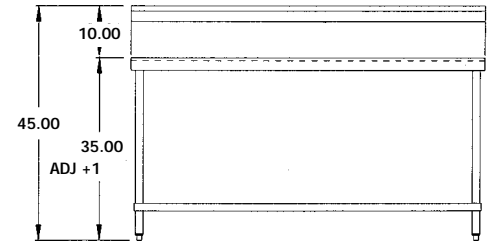
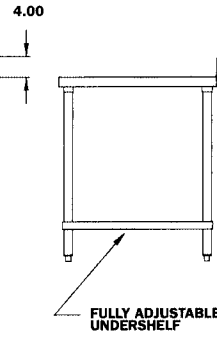
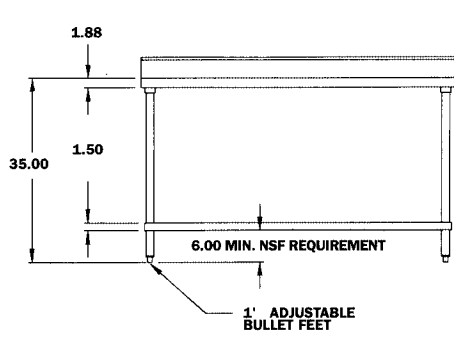
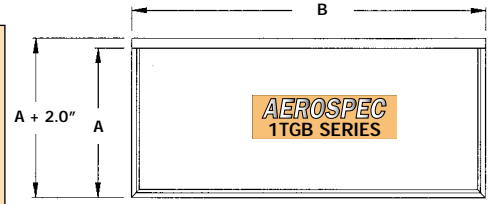
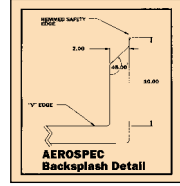
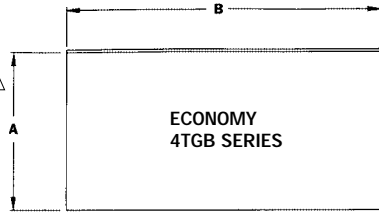

A Width	B Length	ECONOMY 16GA 430 Model #	DELUX 16GA 304 Model #	PREMIUM 14GA 304 Model #	AEROSPEC 14GA 304 Model #	Ship Weight	Cubic Feet
<b>24" WIDE</b>							
24	24	4TGB-2424	3TGB-2424	2TGB-2424	1TGB-2424	50	5
24	30	4TGB-2430	3TGB-2430	2TGB-2430	1TGB-2430	55	6
24	36	4TGB-2436	3TGB-2436	2TGB-2436	1TGB-2436	66	7
24	48	4TGB-2448	3TGB-2448	2TGB-2448	1TGB-2448	81	9
24	60	4TGB-2460	3TGB-2460	2TGB-2460	1TGB-2460	95	12
24	72	4TGB-2472	3TGB-2472	2TGB-2472	1TGB-2472	113	14
24	84	4TGB-2484	3TGB-2484	2TGB-2484	1TGB-2484	135	16
24	96	4TGB-2496	3TGB-2496	2TGB-2496	1TGB-2496	150	18
24	108	4TGB-24108	3TGB-24108	2TGB-24108	1TGB-24108	165	21
24	120	4TGB-24120	3TGB-24120	2TGB-24120	1TGB-24120	268	28
24	132	4TGB-24132	3TGB-24132	2TGB-24132	1TGB-24132	301	36
24	144	4TGB-24144	3TGB-24144	2TGB-24144	1TGB-24144	316	39

<b>30" WIDE</b>							
30	24	4TGB-3024	3TGB-3024	2TGB-3024	1TGB-3024	56	6
30	30	4TGB-3030	3TGB-3030	2TGB-3030	1TGB-3024	70	7
30	36	4TGB-3036	3TGB-3036	2TGB-3036	1TGB-3036	77	9
30	48	4TGB-3048	3TGB-3048	2TGB-3048	1TGB-3048	92	11
30	60	4TGB-3060	3TGB-3060	2TGB-3060	1TGB-3060	111	14
30	72	4TGB-3072	3TGB-3072	2TGB-3072	1TGB-3072	129	17
30	84	4TGB-3084	3TGB-3084	2TGB-3084	1TGB-3084	153	20
30	96	4TGB-3096	3TGB-3096	2TGB-3096	1TGB-3096	171	22
30	108	4TGB-30108	3TGB-30108	2TGB-30108	1TGB-30108	195	25
30	120	4TGB-30120	3TGB-30120	2TGB-30120	1TGB-30120	294	40
30	132	4TGB-30132	3TGB-30132	2TGB-30132	1TGB-30132	331	43
30	144	4TGB-30144	3TGB-30144	2TGB-30144	1TGB-30144	346	47

<b>36" WIDE</b>							
36	36	4TGB-3636	3TGB-3636	2TGB-3636	1TGB-3636	92	10
36	48	4TGB-3648	3TGB-3648	2TGB-3648	1TGB-3648	101	14
36	60	4TGB-3660	3TGB-3660	2TGB-3660	1TGB-3660	121	17
36	72	4TGB-3672	3TGB-3672	2TGB-3672	1TGB-3672	142	20
36	84	4TGB-3684	3TGB-3684	2TGB-3684	1TGB-3684	160	23
36	96	4TGB-3696	3TGB-3696	2TGB-3696	1TGB-3696	169	27
36	108	4TGB-36108	3TGB-36108	2TGB-36108	1TGB-36108	189	30
36	120	4TGB-36120	3TGB-36120	2TGB-36120	1TGB-36120	315	46
36	132	4TGB-36132	3TGB-36132	2TGB-36132	1TGB-36132	358	51
36	144	4TGB-36144	3TGB-36144	2TGB-36144	1TGB-36144	373	55

All dimensions are typical (tol. ±1/2"). • For Accessories and Options see pages TS-5A, TS-5B.